



# DL-6140-201

## High Power Laser Diode

### Overview

DL-6140-201 is high power (50mW) 785nm laser diode.  
DL-6140-201 is suitable for CD-R.

### Features

- High power : 50 mW at 60°C
- Index guided type
- Small package : 5.6 mm  $\phi$
- PIN photodiode built-in for light output monitor

### Absolute Maximum Ratings at Tc=25°C

Parameter	Symbol	Ratings	Unit
Light Output	Po	55	mW
Reverse Voltage	Laser	2	V
	PIN	30	
Operating Temperature	Topr	-10 to +60	°C
Storage Temperature	Tstg	-40 to +85	°C

### Package Dimensions

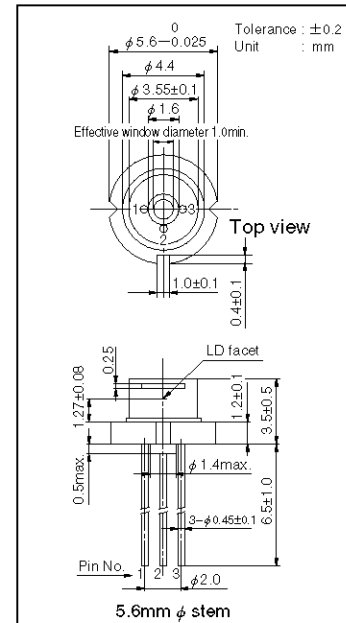

### Electrical Connection

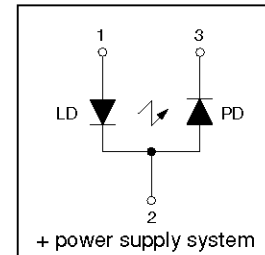

### Electrical and Optical Characteristics at Tc=25°C

Parameter	Symbol	Condition	Min.	Typ.	Max.	Unit	
Threshold Current	I <sub>th</sub>	CW	20	30	50	mA	
Operating Current	I <sub>op</sub>	Po=50mW	-	100	140	mA	
Operating Voltage	V <sub>op</sub>	Po=50mW	-	2.0	2.5	V	
Lasing Wavelength	$\lambda_p$	Po=50mW	775	785	795	nm	
Beam Divergence ※)	Perpendicular	$\theta_{\perp}$	Po=50mW	18	22	26	deg.
	Parallel	$\theta_{\parallel}$	Po=50mW	7.0	8.5	9.5	deg.
Off Axis Angle	Perpendicular	$\Delta\theta_{\perp}$	-	-	±3	deg.	
	Parallel	$\Delta\theta_{\parallel}$	-	-	±3	deg.	
Differential Efficiency	dPo/dI <sub>op</sub>	-	0.40	0.70	0.90	mW/mA	
Monitoring Output Current	I <sub>m</sub>	Po=50mW	0.05	0.20	0.50	mA	
Astigmatism	A <sub>s</sub>	Po=50mW	-	10	-	$\mu$ m	

※) Full angle at half maximum note : The above product specifications are subject to change without notice.

**SANYO Electric Co.,Ltd. Semiconductor Business Headquarters**

TOKYO OFFICE Tokyo Bldg., 1-10, 1 Chome, Ueno, Taito-ku, TOKYO, 110 JAPAN

N2897 GI, (IM) No.5872 1/3

## Characteristics

### Output power vs. Forward current

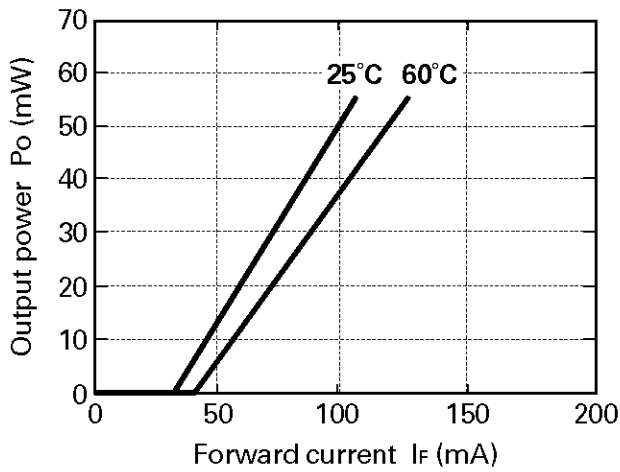

### Threshold current vs. Temperature

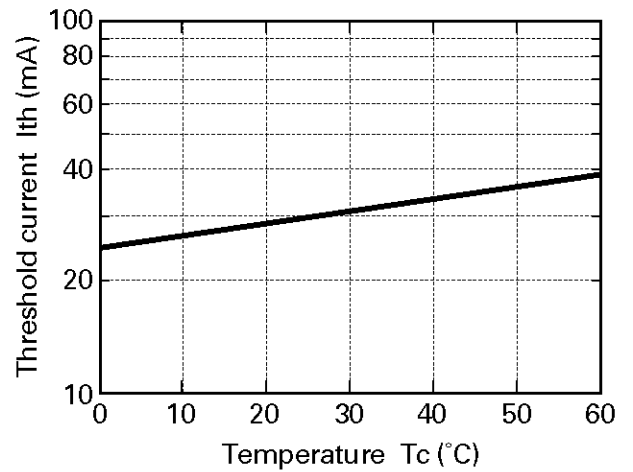

### Monitor current vs. Output power

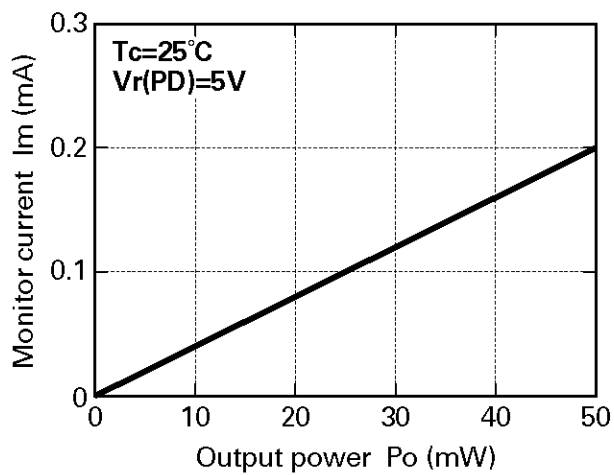

### Beam divergence

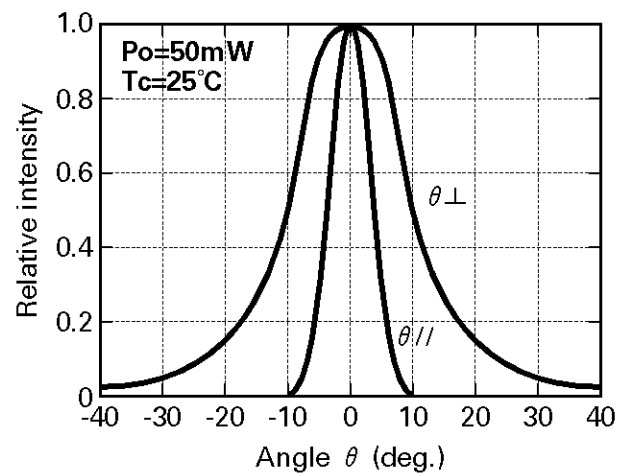

### Lasing wavelength vs. Temperature

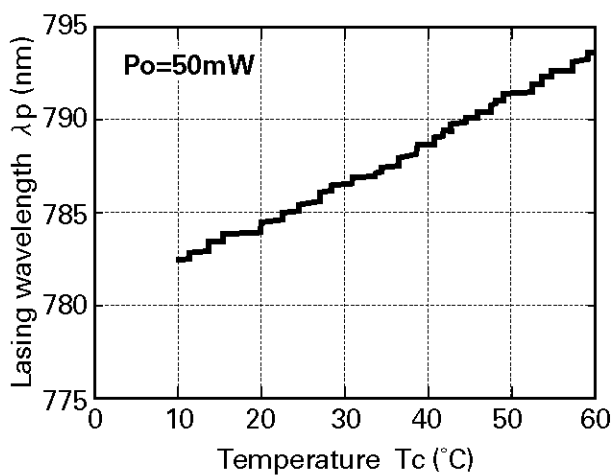

### Output power vs. Lasing wavelength

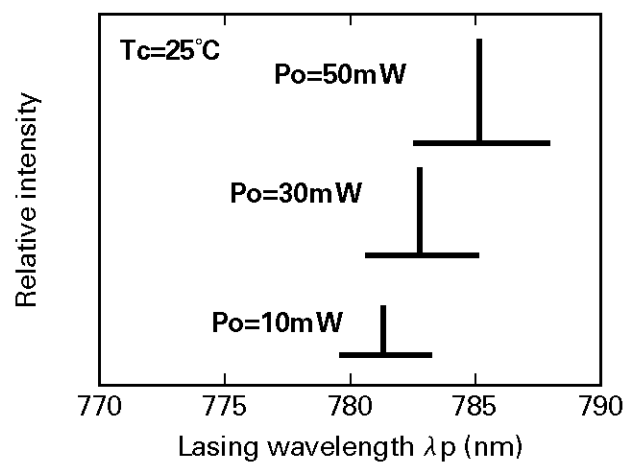

## CAUTION

1. No products described or contained herein are intended for use in surgical implants, life-support systems, aerospace equipment, nuclear power control systems, vehicles, disaster / crime-prevention equipment or the like, and the failure of which may directly or indirectly cause injury, death or property loss.
2. Anyone purchasing any products described or contained herein for an above-mentioned use shall:
  - 1) Accept full responsibility and indemnify and defend SANYO ELECTRIC CO.,LTD., it's affiliates, subsidiaries and distributors or any of their officers and employees, jointly and severally, against any and all claims and litigation and all damages, costs and expenses associated with such use.
  - 2) Not impose any responsibility for any fault or negligence which may be cited in any such claim or litigation on SANYO ELECTRIC CO., LTD., it's affiliates, subsidiaries and distributors or any of their officers and employees jointly or severally.
3. Information (including circuit diagrams and circuit parameters) disclosed herein is for example only; it is not guaranteed for mass production, SANYO believes the information disclosed herein is accurate and reliable, but no guarantees are made or implied regarding it's use or any infringements of intellectual property rights or other rights of third parties.

## Precautionary instructions in handling gallium arsenic products

Special precautions must be taken in handling this product because it contains, gallium arsenic, which is designated as a toxic substance by law. Be sure to adhere strictly to all applicable laws and regulations enacted for this substance, particularly when it comes to disposal.

Manufactured by ; **Tottori SANYO Electric Co., Ltd.**  
Electronics Device Bussiness Headquarters LED Division  
5-318, Tachikawa-cho, Tottori City, 680 Japan  
TEL: +81-857-21-2137 FAX: +81-857-21-2161